

Compassion for Life

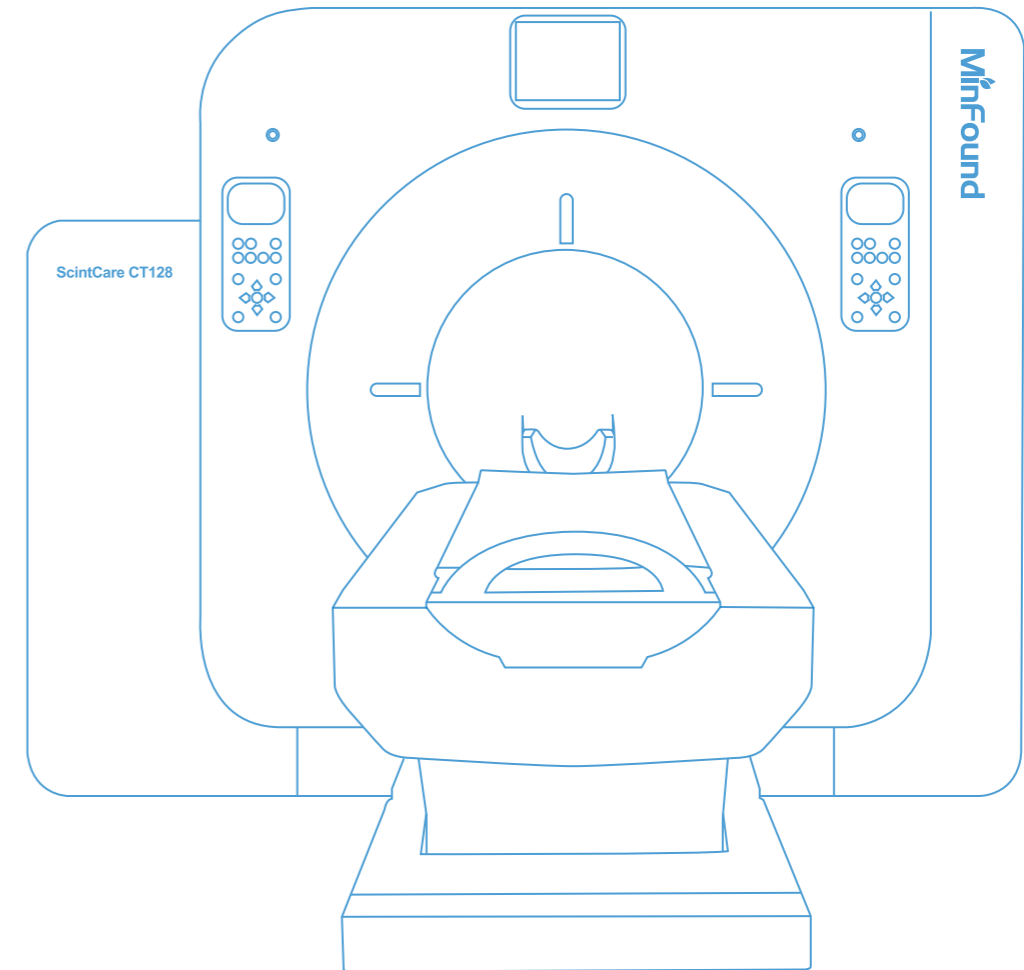

SCINTCARE CT 128

MinFound Medical Systems Co., Ltd.

Address: No. 8 Dongze Road, Jishan Street, Yuecheng District, Shaoxing, China

Phone: +86 400 035 8898

Website: www.minfound.com.cn

Email: info@minfound.com

Version: Minfound-ScintCare CT128-EN-201911

2010-2019 MinFound Medical Systems copyright. Products are subject to change without noticing.

About MinFound

Established in 2011, MinFound Medical Systems Co., Ltd. is a X-ray Computed Tomography (CT) and Positron Emission Tomography (PET) manufacturer with headquarter in Hangzhou, China. FMI is headquartered in Solon, Ohio and is a fully owned subsidiary of MinFound Medical Systems Co., Ltd. In China, there are also Research and Development Centers in Zhongshan and Dalian.

The FMI Operations in the US has been focusing on Research and Development and designing high-end medical imaging equipment in collaboration with the Research and Development team at MinFound. Together we have successfully developed CT and PET/CT Systems. MinFound has successfully obtained the CFDA Clearance and has been selling the CT and PET/CT Systems in China. FMI is successful of obtaining FDA Clearance for the CT Systems with plans of establishing manufacturing operations in Solon, Ohio for producing systems for the global market.

With our company' s core value of "Compassion For Life", we are focused on humanity and are striving to deliver excellent medical imaging equipment and services to aid in the health and quality of life for patients around the world.

World Leading Medical Products and Solutions Supplier

Compassion for life



MinFound is always attentive to what you need and strives to deliver solid and affordable products and solutions to patients all over the world.



MinFound has been driven by innovation, dedicated to developing state-of-the-art products to obtain precise images to enable the very early-staged diagnosis.

MinFound Patented Technology Empowers Acquiring High-Definition Images with Less Radiation Dose.



The all-level-image optimization

Low-dose technology

Comprehensive clinical applications

Key Features

- ScintiStar Detector
- 3D-MAT
- NDI +
- ECG-Mod
- 1024X1024 Matrix

ScintiStar Detector

MinFound ScintCare CT 128 utilizes the state-of-the-art ScintiStar Detector which is well-known as one of the key component of a CT system.



The features of the versatile ScintiStar detector are:

- Designed and developed by the top-notch scientist team
- Made of rare earth ceramic scintillator
- 64-row and 40mm width design





Q-Enhance Technology

Q-Enhance technology is realized by modifying the structure of material to increase the X-ray utilization fundamentally and therefore improves the image quality.



The high-precision cutting process makes the space between material 85µm only and meantime the inserted reflective material will reflect the visible lights effectively which not only prevents the signals of the parallel rows from interfering each other but also increase the X-ray transforming rate. These two features improve the geometrical efficiency up to 99% and display more details of the images.



DNR Engine

ScintCare CT 128 is equipped with 256-channel ASIC chip to transmit the signals to reduce the noise and increase the SNR.

256-channel ASIC chip features more efficient data processing capability with less digital noise to make the signal transmitting path faster and further to enable to display the basic anatomical information.

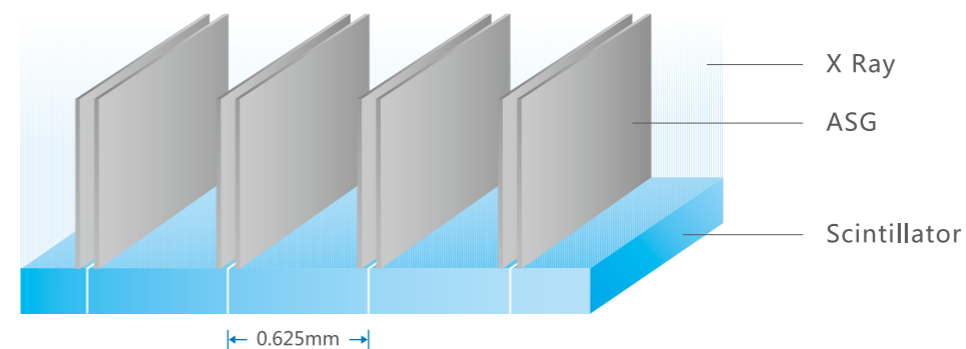

EAA Design

Other than the traditional ASG, each ASG used in ScintCare CT 128 is divided into two discrete grids which will prevent the grids from slanting effectively. The slant grid is usually caused by the temperature shift during operation which will lead to the artifacts eventually.

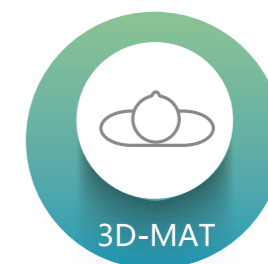
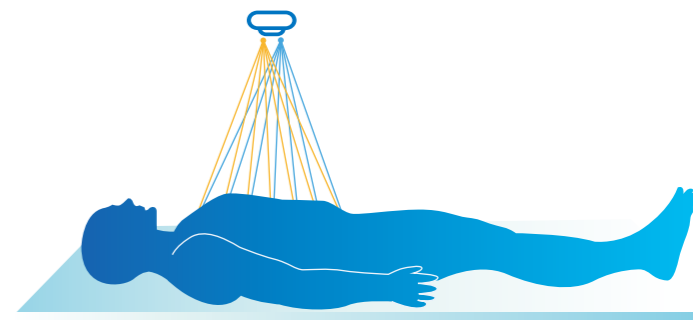
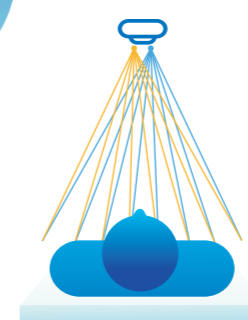

3D-MAT

3D-MAT enables the tube focal spot sampling information at the X-Y dimension and Z direction as well. The technology will be beneficial to more detailed information on the perspective of anatomical structure.



Low-dose Guard Health

NDI⁺

The raw data is iterated simultaneously in the projection space and the image space. The projection space iteration process integrates the physical characteristics of the X-tube and the detector, and the image space iteration process is based on the deep learning network of the anatomical structure. NDI⁺ guarantees the image quality at low dose.

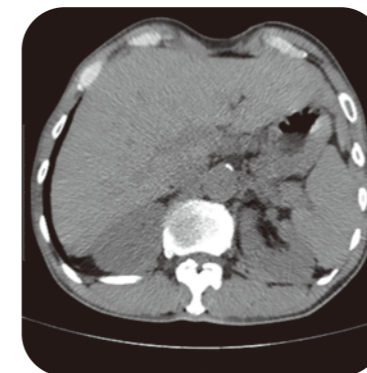
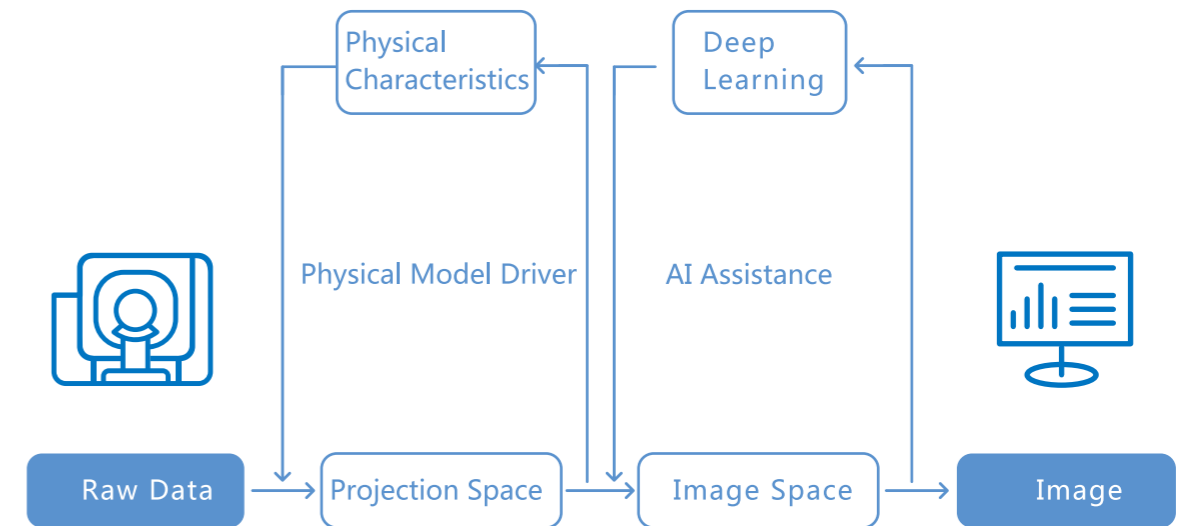

80mAs

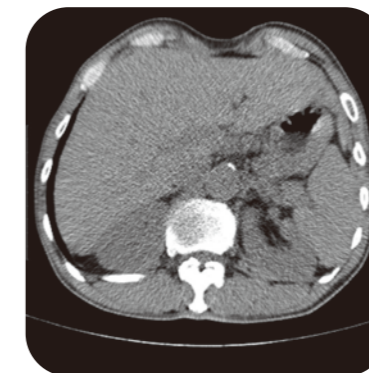

24mAs



24mAs+NDI⁺

ECG-Mod Coronary Dose Adjustment

Through retrospective ECG gating technology and intelligent mA technology, the X-tube current during cardiac scanning is adaptively adjusted, and the radiation measurement is significantly reduced by 65%.



Coronary Artery Image

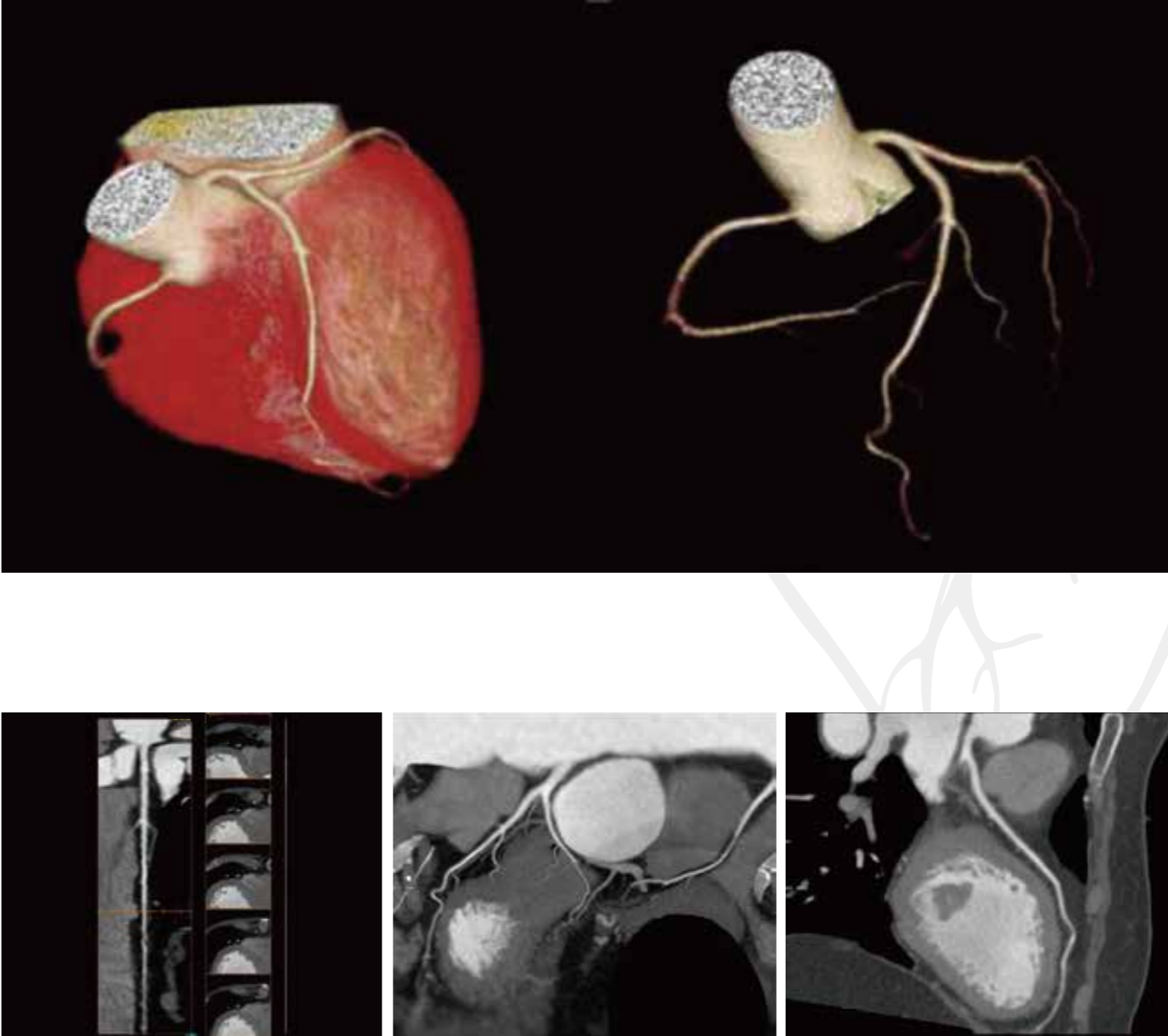

High Definition Image

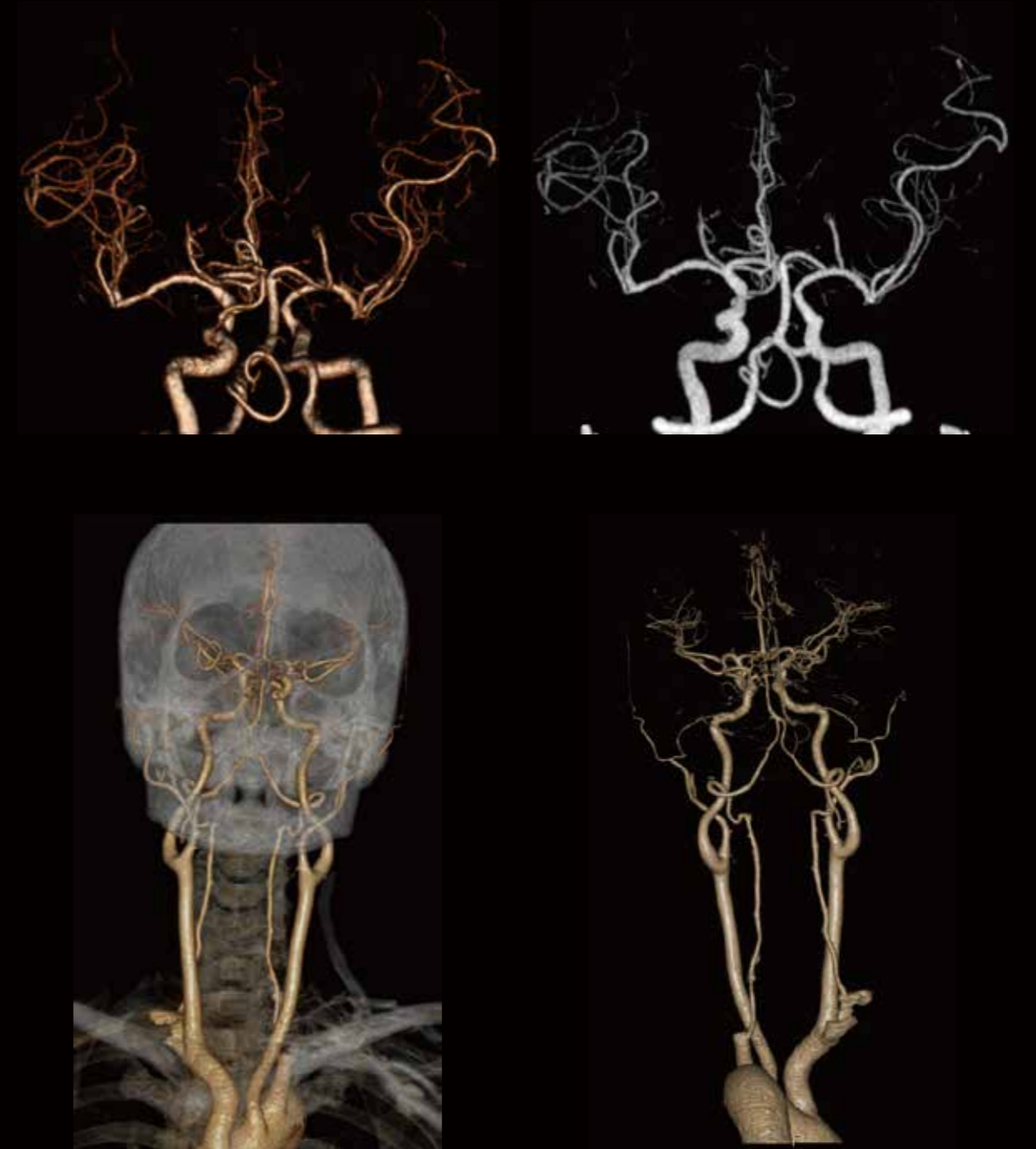

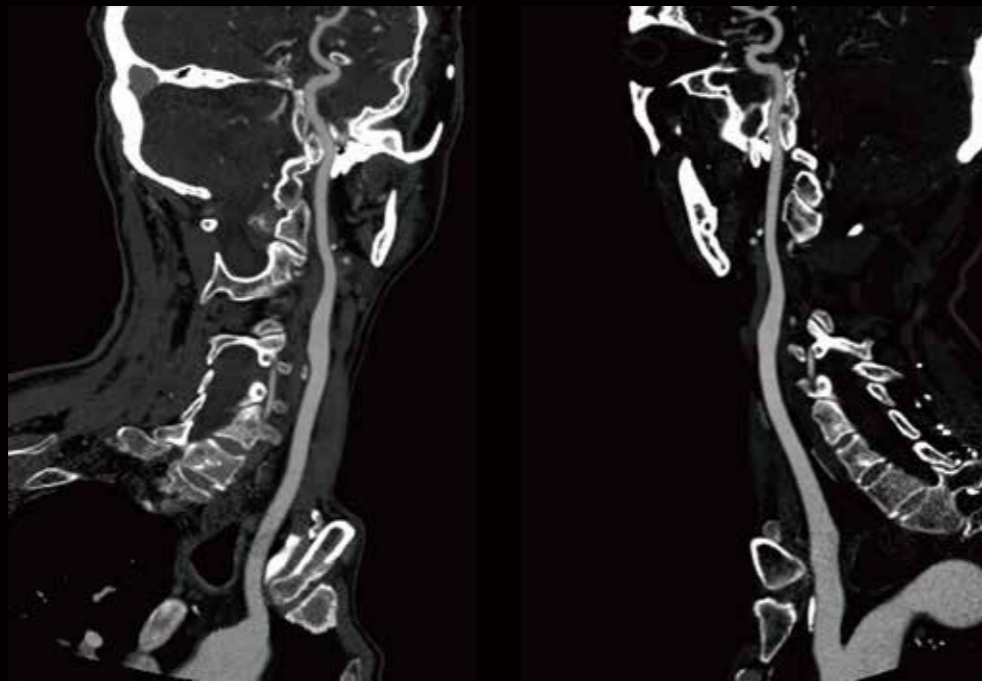
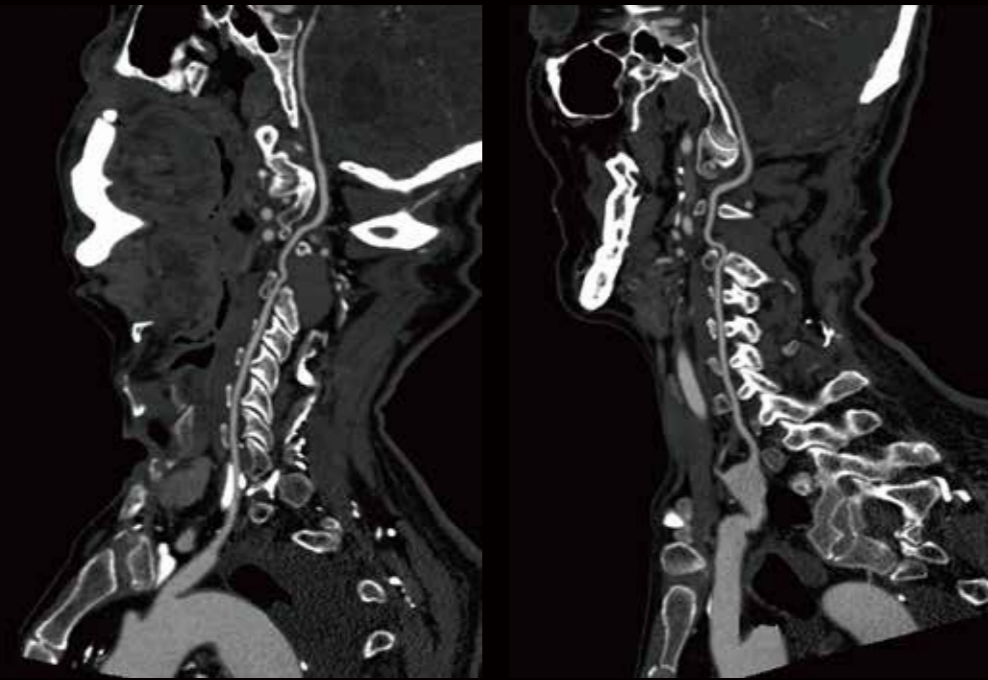

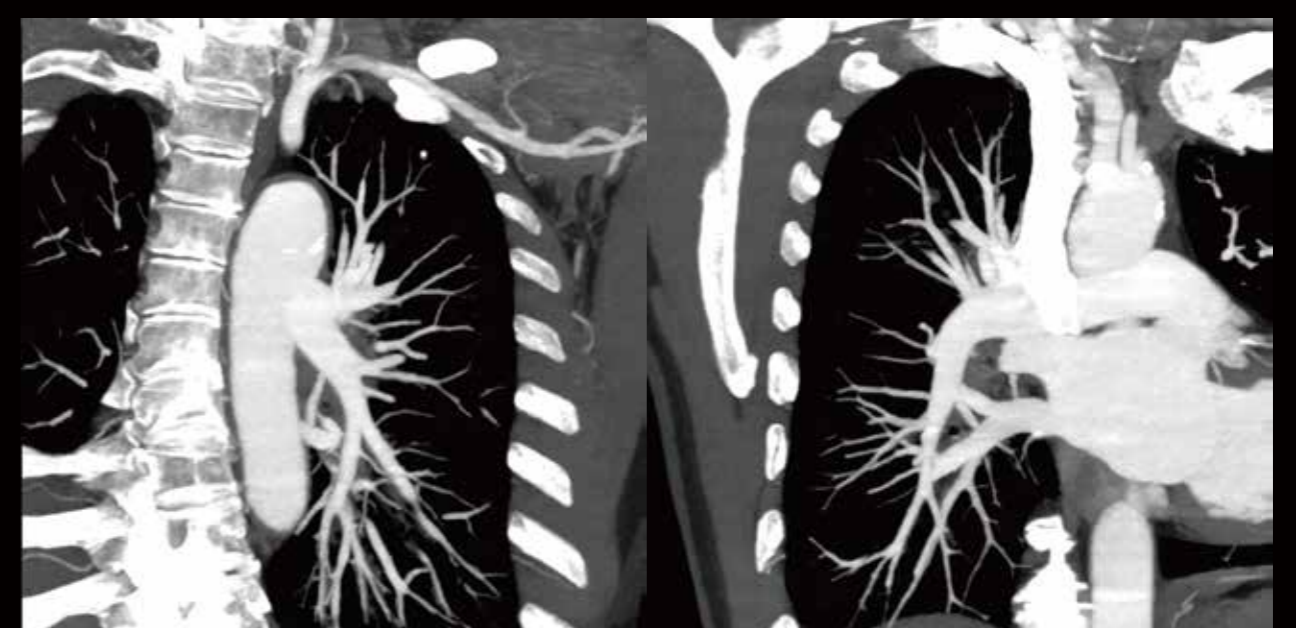
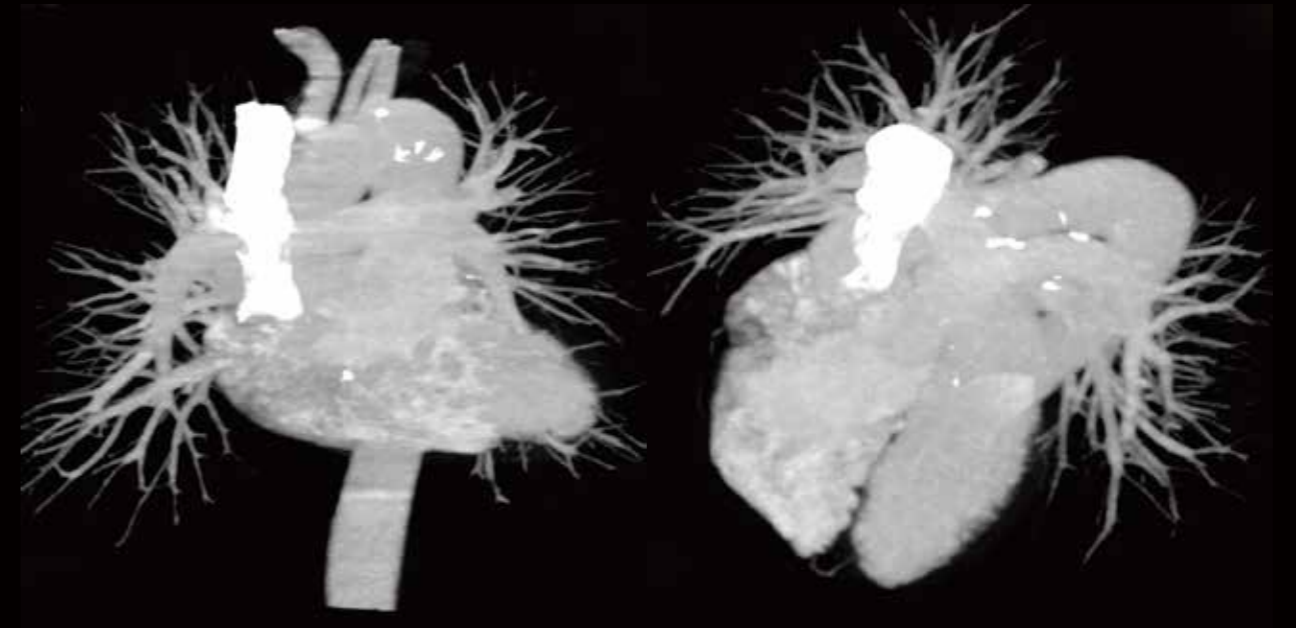



F



F



F

High-end Hardware System

Stable, Reliable and Durable

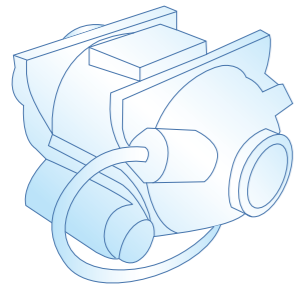

Anode Heat Storage Capacity : 8.0MHU
HV Generator Power Rate : 80KW
Meet clinical needs for fast, wide range, long time scanning.

The Integrated Casting of Stator and Rotor

During Rotation
· Minimum Vibration
· Minimum Deformation

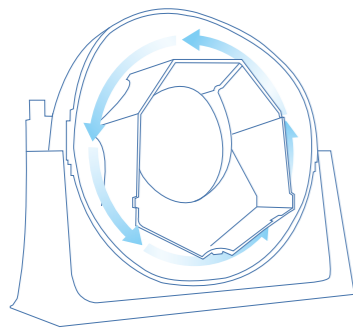
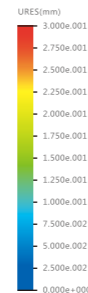
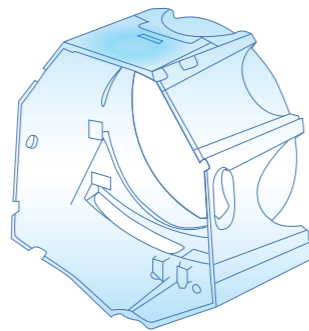

Thermal Isolation Design
The service life of the detector is greatly extended and the image quality attenuation of the equipment is reduced

UI & Workflow

- User-focused design to operate easily
- The comprehensive function fit users' needs
- Human-centered design for customized protocols



MinFound Cloud Solution

Cloud Diagnosis

Famous radiologists diagnose through remote image diagnosis solution, improving primary hospital diagnosis ability.



Cloud Storage

MinFound Cloud storage is safe, stable and able to save much cost: payable based on requirement; it saves equipment purchasing and operation cost.

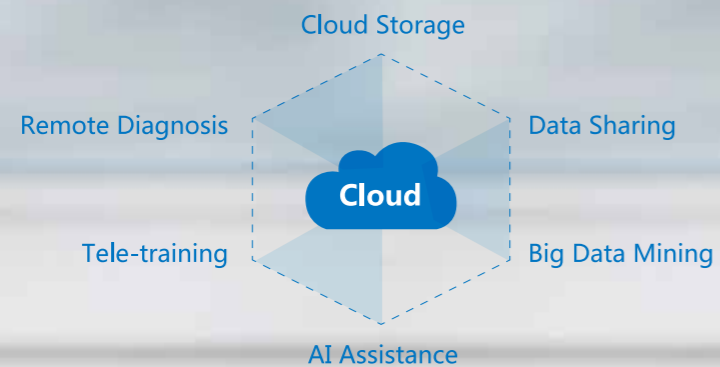

Global After-sales Service

Attentive, Quick and Professional. Leave you nothing to worry about.

Automatic Fault Warning Function

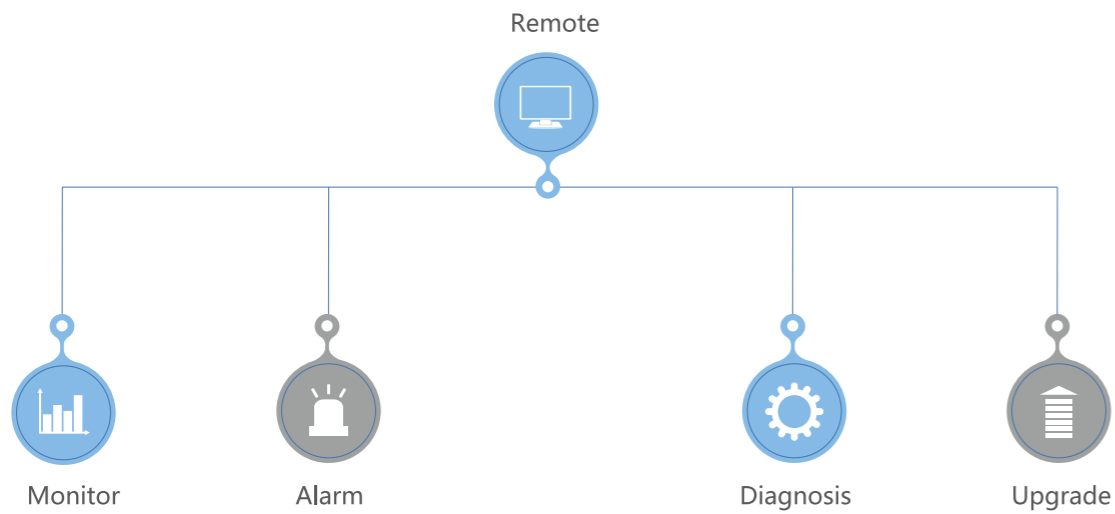





MinFound has been proved as an outstanding success in global market.



Remote Service System

It remotely monitors equipment condition, diagnoses malfunctions and upgrades software.



- 
Hot-line:
+86 400 035 8898
- 
Wechat Official
Accounts
- 
24 Hrs Engineer
Online Reply
- 
Mobile Application
(IOS/Android)